

1

2

3

4

版本 REV.	變更內容 MODIFICATION	日期 DATE	修改 DRAW	核準 APPROVE

字符:黑色油墨印刷

A

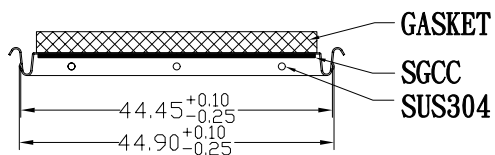

B

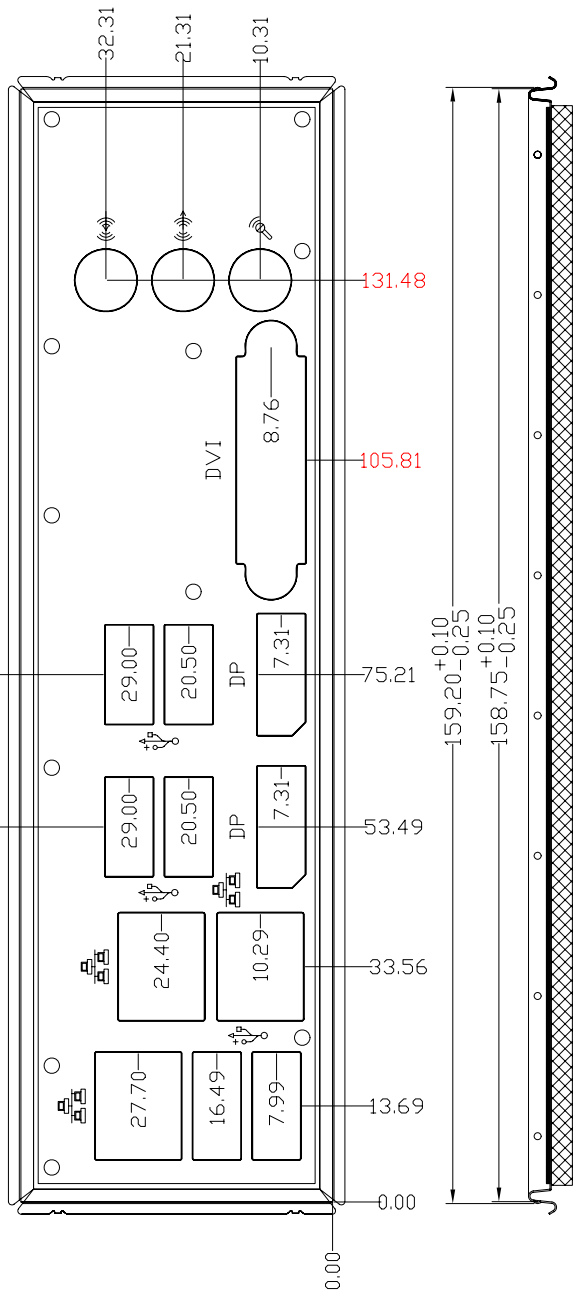

C

D

E

A

B

C

D

E

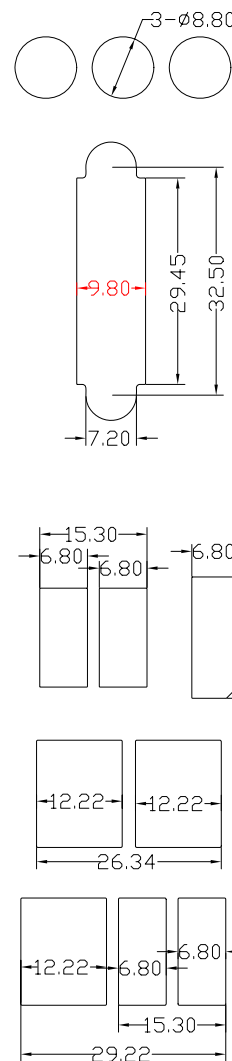
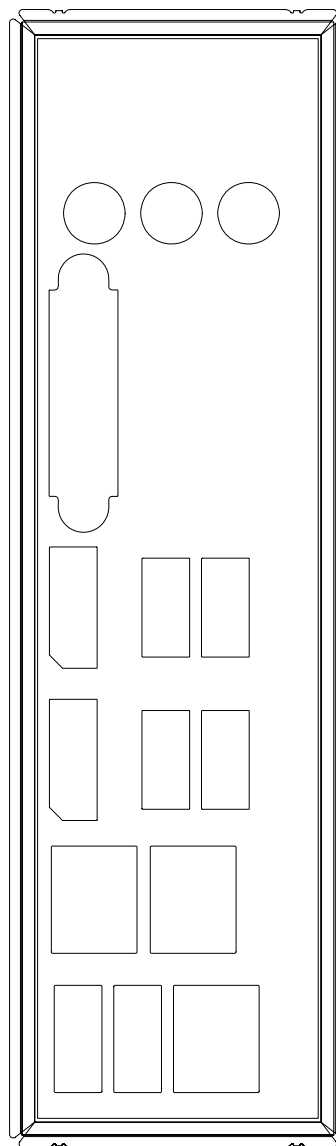

GENERAL TOLERANCE : ±0.2MM

KUANGYING

東莞廣迎五金塑膠制品有限公司

KUANGYING COMPUTER EQUIPMENT CO., LTD TEL:+86-769-85413055 FAX:+86-769-85413054

F	本產品不含以下物質，符合【廣迎有害物質技術標準】(B-0021)之規定		0-6	±0.05	單位 UNIT	mm	製圖 DRAWING	Qing	圖號 DWG NO.		KTQM67_REAR10		F
			6-30	±0.10					模號 DWG NO.				
	1. 鎘 Cd, cadmium	5多溴聯苯 PBB	30-180	±0.15	材質 MATERIAL	SUS304 T=0.2mm SGCC T=0.5mm	設計 DESIGN	Qing	品名 TITLE		IOA-02121-T0		
	2. 鉛 Pb, Lead	6多溴聯苯醚 PBDE	180以上	±0.20					規格步距 WIDTH PH		審核 CHECKED		
3. 汞 Hg, Mercury		熱處理 HEATING		日期 DATE		11.5.09	核準 APPROVE	角法 PROJ.		成品圖 PRODUCT DWG			
4. 六價鉻化合物 Hexavalent-Chromium Compounds (Cr+6)		表面處理 FACE HEATING											

1

2

3

4

1

2

3

4

版本 REV.	變更內容 MODIFICATION	日期 DATE	修改 DRAW	核準 APPROVE

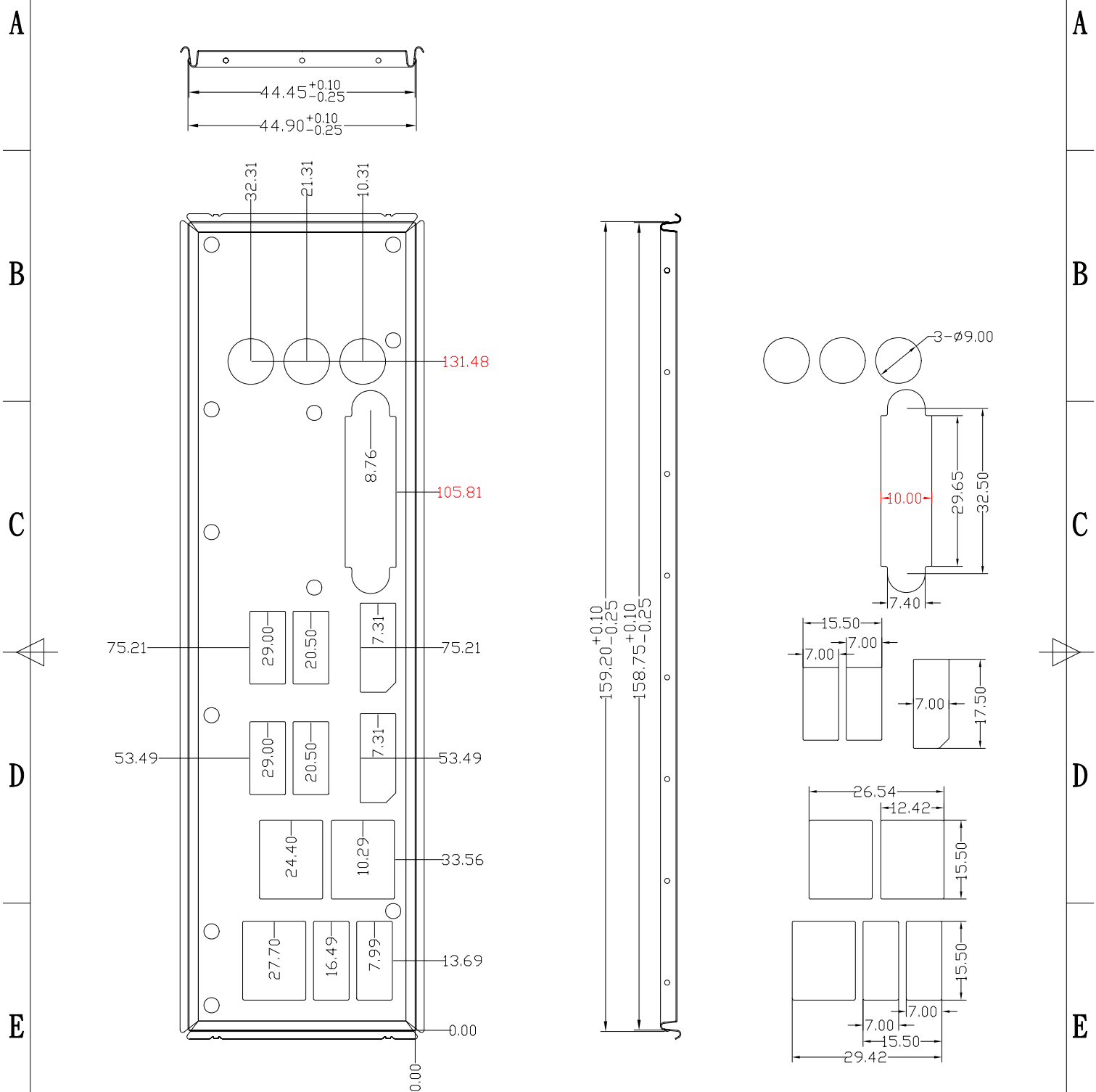

GENERAL TOLERANCE : ±0.2MM

KUANGYING

東莞廣迎五金塑膠制品有限公司

KUANGYING COMPUTER EQUIPMENT CO., LTD TEL:+86-769-85413055 FAX:+86-769-85413054

F	本產品不含以下物質，符合【廣迎有害物質技術標準】(B-0021)之規定		0-6	±0.05	單位	mm	製圖	Qing	圖號		KTQM67_REARIO(SUS)		F
			6-30	±0.10	UNIT		DRAWIN		模號				
	1. 鎘 Cd, cadmium		30-180	±0.15	材質	SUS304	設計	Qing	DWG NO.				
	2. 鉛 Pb, Lead		180以上	±0.20	MATERIAL	T=0.2mm	審核		DWG NO.				
	3. 汞 Hg, Mercury		熱處理		規格步距		CHECKED		品名		10A-02121-T0(SUS)		
4. 六價鉻化合物 Hexavalent-Chromium Compounds (Cr ⁶⁺)		表面處理		日期	11.5.09	核準		比例		1:1	版本	A0	
		FACE HEATING		DATE		APPROVE		SCALE			成品圖		
								角法		PRODUCT DWG			

1

2

3

4

1

2

3

4

版本 REV.	變更內容 MODIFICATION	日期 DATE	修改 DRAW	核準 APPROVE

字符:黑色油墨印刷

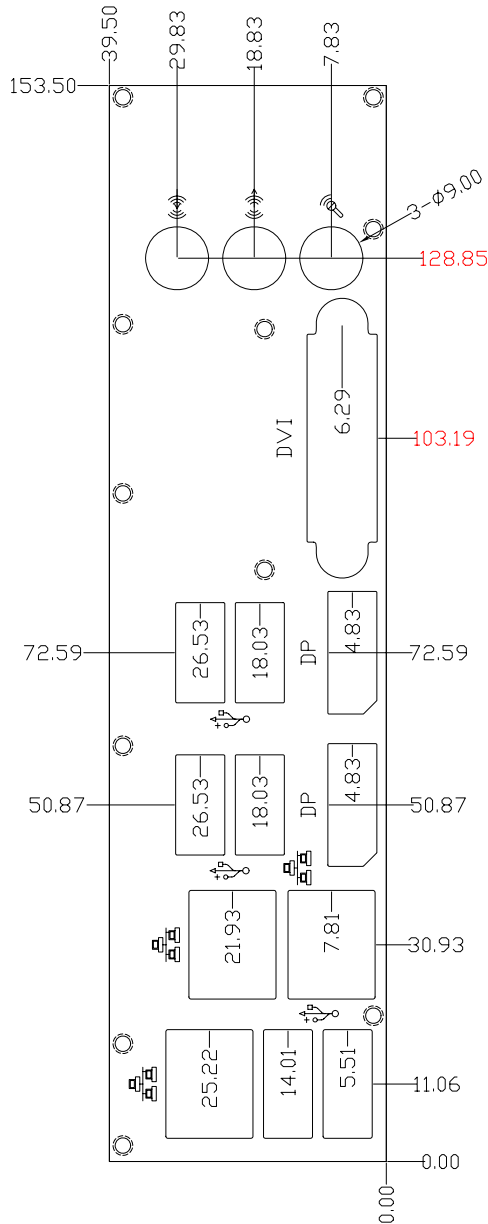

0.50

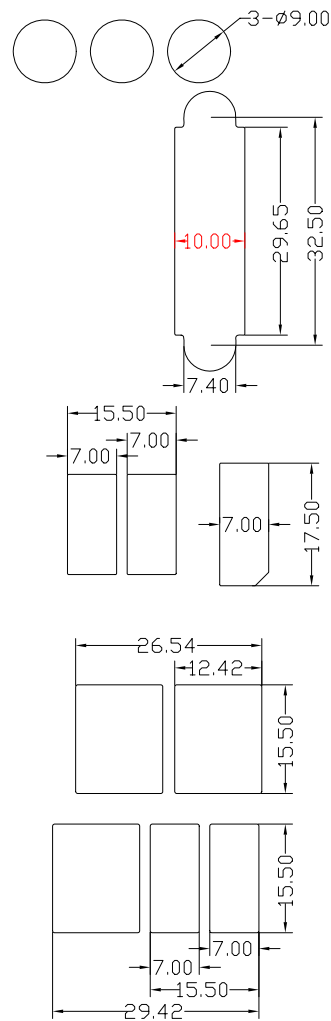

GENERAL TOLERANCE : ±0.2MM

KUANGYING

東莞廣迎五金塑膠制品有限公司

KUANGYING COMPUTER EQUIPMENT CO., LTD TEL:+86-769-85413055 FAX:+86-769-85413054

F	本產品不含以下物質，符合【廣迎有害物質技術標準】(B-0021)之規定		0-6	±0.05	單位 UNIT	mm	製圖 DRAWING	Qing	圖號 DWG NO.		KTQM67_REARIO(SGCC)		F
			6-30	±0.10					模號 DWG NO.				
	1. 鎘 Cd, cadmium	5多溴聯苯 PBB	30-180	±0.15	材質 MATERIAL	SGCC T=0.5mm	設計 DESIGN	Qing	品名 TITLE		IOA-02121-T0(SGCC)		
	2. 鉛 Pb, Lead	6多溴聯苯醚 PBDE	180以上	±0.20					規格步距 WIDTH PH		審核 CHECKED		比例 SCALE
	3. 汞 Hg, Mercury		熱處理 HEATING		日期 DATE	11.5.09	核準 APPROVE	表面處理 FACE HEATING		角法 PROJ.		成品圖 PRODUCT DWG	
4. 六價鉻化合物 Hexavalent-Chromium Compounds													

1

2

3

4

1

2

3

4

版本 REV.	變更內容 MODIFICATION	日期 DATE	修改 DRAW	核準 APPROVE

A

A

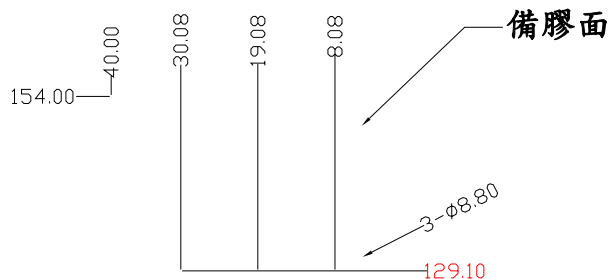

3.00

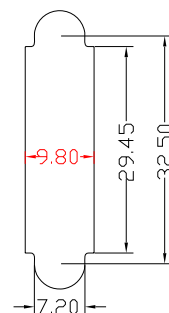
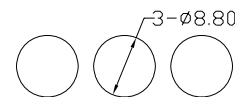

6.54
103.44

72.84
26.78
18.28
5.08

51.12
26.78
18.28
5.08

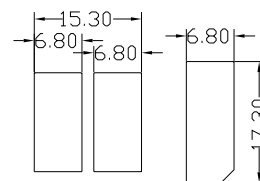

22.18
8.06
31.18

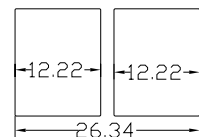

25.47
14.26
5.76
11.31

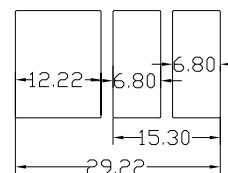

0.00
0.00

B

C

D

E

KUANGYING COMPUTER EQUIPMENT CO., LTD TEL:+86-769-85413055 FAX:+86-769-85413054

本產品不含以下物質，符合【廣迎有害物質技術標準】(B-0021)之規定

0-6	±0.05
6-30	±0.10
30-180	±0.15
180以上	±0.20

材質
MATERIAL

GASKET
T=3.0mm

審核

Qing KTQM67_REARIO(GASKET)

Qing IOA-02121-T0(GASKET)

F

規格步距
WIDTH PH

11.5.09

A0

成品圖
PRODUCT DWG

2

3